

COMBIGRIND SERIES – CG 160 / CG 225 / CG 300 / CG 400

MEAT GRINDING TO THE UTMOST PERFECTION



CG 400



CG 300



CG 225



CG 160

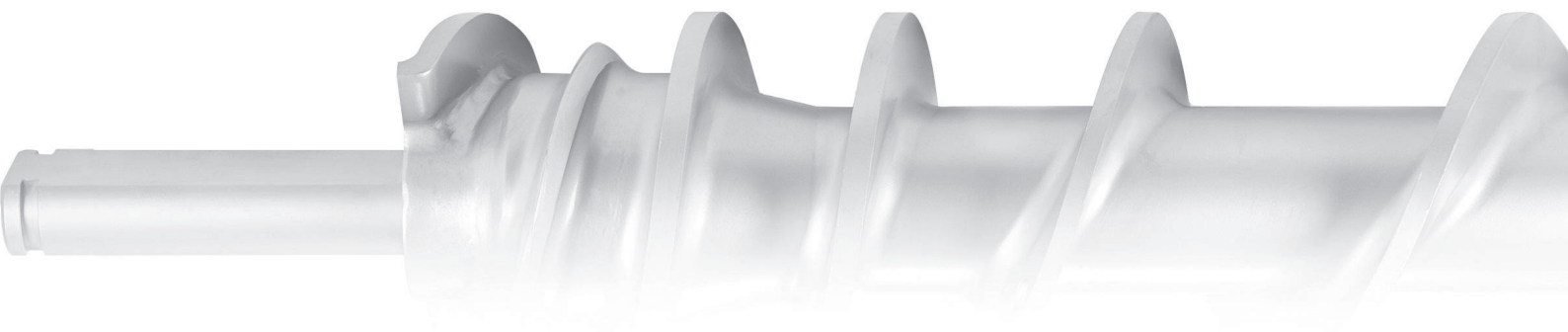

Dual worm grinders for an excessive assortment of ground products

This truly unique and universal new generation of meat grinders is providing the most excellent grinding results, fully comparable and even surpassing those of conventionally specialised grinders for fresh, tempered or deep frozen blocks without changing anything but the incoming raw materials to be ground, coarse or fine as required



The electrical panel is embedded into the machine cabinet. The electrical panel can swing away in order to grant full access to the interior of the machine for maintenance etc.

Minimum product stress provide ground end products with reduced fat separation during cooking and improved drying and curing ability. Variable speed drives for both feeding and grinding worm provide a balanced and constant flow to the cutting set, single or double.

Easy access to all inner parts which require maintenance attention such as periodical tightening and lubrication.

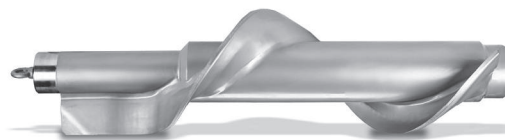

High performance grinding within a wide capacity range is achieved through a low tolerance rigid design with smoothly shaped worms, hand forged, welded and ground superfine by skilled danish craftsmen combined with the smooth surfaces of the high precision CNC milled lining.

Fresh soft meats and fats as well as tempered or hard frozen blocks are effectively processed together or separately without changing any mechanical components due to the ingenious design of hopper, transfer area between the worms combined with effective fixation of the frozen blocks. Narrow tolerances eliminates backwash, fines and smearing.

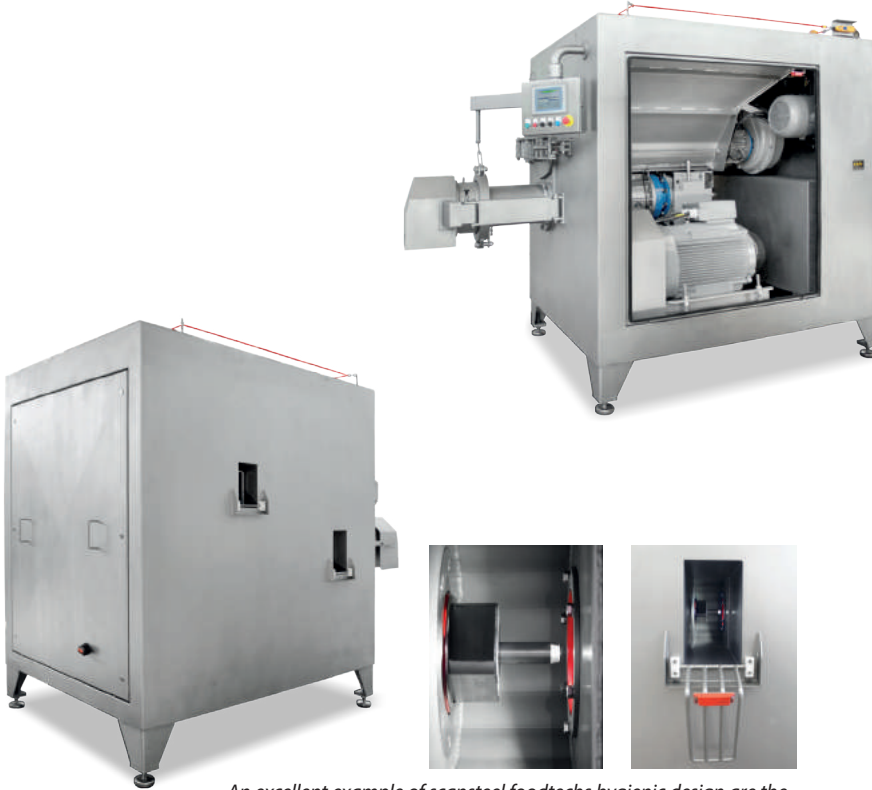

An excellent example of scansteel foodtechs hygienic design are the two hygienic zones, one positioned between each of the augers/worms and the gear boxes.



Low noise level achieved by means of over dimensioned hopper walls and silent gearboxes and motors from well acknowledged european manufacturers

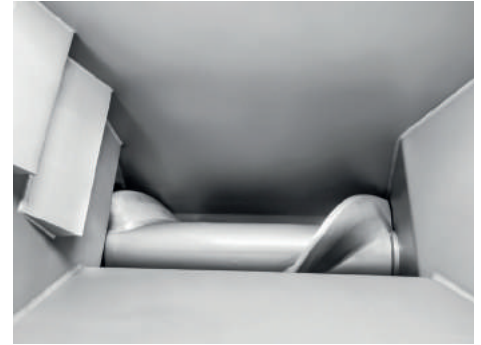

Operator control with easy to understand push button operation of start - stop and emergency. Pre-set of worm speeds and programming functions with logically designed graphics on the touch panel. Programmes with fixed settings for different products can be keyed in with pass word protection. The ScanControl function can be set to optimize the feeder worm speed in relation to the grinder worm load, thus reducing grinder flow fluctuations.

Easy and effective cleaning of both feeding worm and grinding worm, which can easily be disassembled and removed together with other grinding tools by means of the included tool trolleys. Holeplates are easily removed and replaced during production with the included extraction tool, fitting the inner thread in the holeplate center hole.

The hygienic design provides easy access and cleaning of all surfaced in contact with the product. The product area and drive components such as bearings etc are completely separated by means of wide flushing channels with full visibility and access to bearing sealings and drive clutches. This provides full food safety as it is impossible for lubricants or bearing impurities to enter into the product zone. Foldable safety fences prevent accessto rotating parts during operation All surfaces are either smoothly polished or ground and glass bead peaned

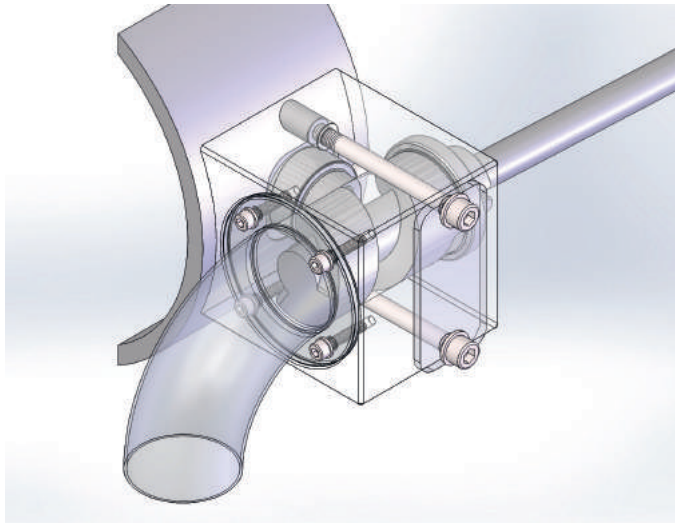

Perfect grinding of all commonly used meat raw materials with Scan Inox* knivesets, manufactured from the finest through hardened steels which, when running pairwise, are designed to provide long lasting performance with minimum wear and long sharpening overhaul intervals. Original Scan Inox* knives are available with machined cutting edges or with replaceable quality steel inserts.



Effective removal of bone chips and other hard particles with the new CCR Continuous Chip Remover, with variable speed which can be set to remove up to 1% of the product flow.

Cleaning trolley for large breaker/feeding auger/worm. For cleaning and easy removal of the breaker/feeding worm/auger

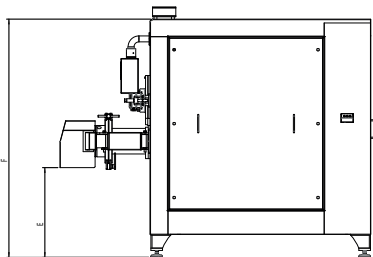

**Danish quality
equipment, conceived
engineered and
manufactured
in Denmark**

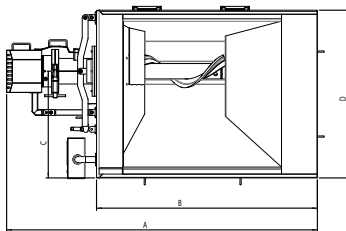

**scansteel
foodtech**

scansteel foodtech
Industrivej 6
4200 Slagelse
Denmark

Phone: +45 7027 1410
Fax: +45 7027 1411

www.scansteelfoodtech.com

Technical specification	Unit	CombiGrind CG 160	CombiGrind CG 225	CombiGrind CG 300	CombiGrind CG 400
Motor - Breaker/feeding worm/auger	kW	9 kW	11 kW	15 kW	22 kW
Motor - Grinder worm/auger	kW	30 kW	55 or 75 kW	75 or 90 kW	90 or 110 or 132 kW
Total length - A	mm	2350	2675	2920	3280
Length of cabinet - B	mm	1700	1900	2010	2400
C	mm	760	920	980	1175
D	mm	1250	1445	1545	1850
E	mm	775	775	775	790
F	mm	1900	2050	2060	2425